

PHOTON (30M) INFRARED BEAMS/PHOTOCELLS POCKET INSTALLATION GUIDE



Photon

Centurion Systems (Pty) Ltd



Facebook: [facebook.com/CenturionSystems](https://www.facebook.com/CenturionSystems)

YouTube: [YouTube.com/CenturionSystems](https://www.youtube.com/CenturionSystems)

Twitter: [@askCentSys](https://twitter.com/askCentSys)

Subscribe to the newsletter: www.CentSys.com.au/Subscribe

www.CentSys.com.au

Call Centurion Systems (Pty) Ltd South Africa
Head Office: +27 11 699 2400

Call Technical Support: +27 11 699 2481
from 07h00 to 18h00 (GMT+2)

www.centsys.com

E&OE Centurion Systems (Pty) Ltd reserves the right to change any product without prior notice. All product and brand names in this document that are accompanied by the ® symbol are registered trademarks in South Africa and/or other countries, in favour of Centurion Systems (Pty) Ltd, South Africa.

The CENTURION and CENTSYS logos, all product and brand names in this document that are accompanied by the TM symbol are trademarks of Centurion Systems (Pty) Ltd, in South Africa and other territories; all rights are reserved.

We invite you to contact us for further details.



DOC: 1227.D.01.0001_09072018
SAP:

1. Introduction

Photon infrared gate safety beams/photocells have been designed to provide an integral element of safety to an automated system while at the same time affording the installer considerable freedom during the installation process. The transmitter is completely wireless – being powered via two AA Alkaline batteries – obviating the need for tunnelling and digging and subsequent defacement of one's driveway for the purpose of running cables. Not only does this arrangement allow for significant flexibility and fewer restrictions when it comes to mounting the beams, but it dramatically reduces material and labour costs.

2. Safety Instructions



- All installation, repair, and service work to this product must be done by a suitably qualified person.
- Do not in any way modify the components of the system.
- Do not leave packing materials (plastic, polystyrene, etc.) within reach of children as such materials are potential sources of danger.
- Dispose of all waste products like packing materials, according to local regulations.
- We do not accept any liability caused by improper use of the product, or for use other than that for which the automated system was intended.
- This product was designed and built strictly for the use indicated in this documentation. Any other use, not expressly indicated here, could compromise the service life/operation of the product and/or be a source of danger.
- Anything not expressly specified in these instructions is not permitted.

3. Icons used in this guide



This icon denotes variations and other aspects that should be considered during installation



This icon indicates warning, caution or attention! Please take special note of critical aspects that MUST be adhered to in order to prevent injury

4. Operation

When connected to an automated system such as a gate motor or garage door operator, the **Photon** beams/photocells aid in preventing personal injury, and/or property damage due to crushing, when used in a closing beam configuration. When used in an opening beam configuration, the **Photon** beams/photocells dramatically reduce the hazardous actions associated with a gate that is opening; such as dragging or shearing.

The operation of the **Photon** beams/photocells relies upon the infrared beam being interrupted by a person or object, and notifying a device connected to its fail-safe contact, of the interruption.

In addition, **Photon** beams/photocells are compatible with the unique Intruder-detection Alarm functionality inherent in some of our gate operators. These operators allow the **Photon** beams/photocells to act as sophisticated perimeter security devices by activating an alarm on the operator's controller, or a third-party alarm system, whenever the beams/photocells have been obstructed or remain obstructed for a predefined period of time.

Refer to the relevant product documentation for further information about Intruder-detection Alarm functionality.

5. Technical specifications

| | |
|----------------------------|---|
| Power supply | Transmitter: 2 x AA Alkaline batteries (supplied) * |
| | Receiver: 12V – 24V AC 12V – 30V DC |
| | Open Collector: 7.5V – 30V DC |
| Power consumption | Receiver: 30mA @ 12V DC (relay) 15mA @ 12V DC (open collector) |
| Transmitter battery life | Minimum of two years |
| Battery low indication | Audible beep |
| Maximum operating distance | 30m |
| Alignment | Automatic – 1m ² @ 10m ² |
| Output contact | N/C and N/O potential-free, N/C open collector * |
| Output contact rating | 3A @ 30V DC non-inductive/ 50mA @ 30V DC (open collector) |
| Operating temperature | -15°C - +65°C |
| Operating humidity | 0 - 90° non-condensing |
| Housing material | ABS |
| Degree of protection | IP54 |

* Only replace with alkaline batteries; do not use rechargeable batteries

⊕ Circular area – assuming a parallel surface

* Selectable by jumper

6. Installation

Site Consideration

- It is of paramount importance that the beams/photocells are mounted on surfaces that are reasonably parallel to one another. Small differences in the angle between the opposing parallel surfaces can lead to large offsets in alignment between the transmitter and the receiver - the greater the distance that the infrared beam travels between the transmitter and the receiver, the larger the offset.
- The transmitter and receiver are typically mounted directly opposite one another, but some leeway is given in the form of a wide beam being cast should absolute alignment not be possible.

For ease of alignment, an onboard buzzer has been provided on the receiver, that can be activated by placing the **Photon** receiver unit in Installer Mode.

(See points 12 & 13 for installer Mode)

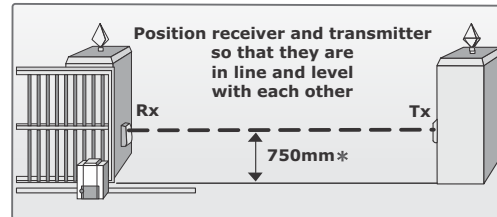

Figure 1.



* Centurion Systems (Pty) Ltd recommends a height of 750mm, but the height of the beam must be tailored to suit the specific requirements of the installation.

Remove cover and prepare for mounting

- Lift the **receiver's** front cover off as illustrated



Opening the cover

Figure 2.

- To expose the mounting holes, remove the PCB from the enclosure by pressing the **red** plastic lever located at the top of the enclosure as shown.

Store the PCB safely to prevent damage.

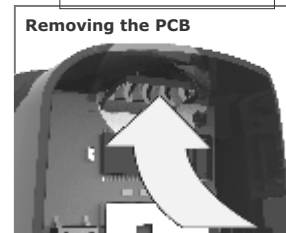

Removing the PCB

Figure 3.

Mounting

- Mark the mounting position of the Photon receiver for a single or double fastener.

- For masonry mounting, use a 5mm masonry drill bit.

For mounting to steel tubing. Use a 2.3mm steel drill bit.

- Mount the base of the **Photon** using the supplied hardware. Ensure that the rubber "O" ring is used to seal the **Photon**

enclosure against insect ingress. For double mounting screws, knock out the thin plastic film - this is recommended to better locate the **Photon** beams and prevent them from twisting.

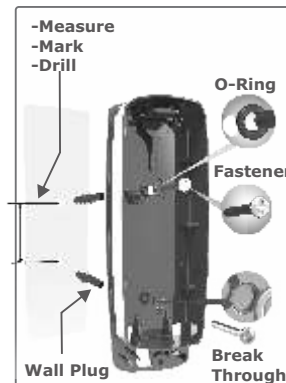

Figure 4.

Re-Inserting the PCB

- Tuck the base of the PCB into the ribs situated at the base of the plastic enclosure. Thereafter swing the PCB into place so that the top lever prevents it from falling out. There should be an audible "click" to lock the PCB in position. Refer to figure 5.

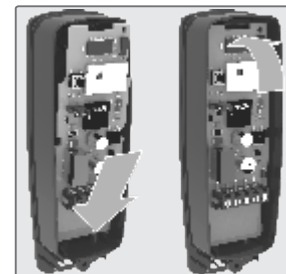

Figure 5.

Receiver Configuration

9. Pay attention to the jumper switch on the receiver as it allows for different configurations.

1&2 - Open collector mode
2&3 - Relay mode (default)

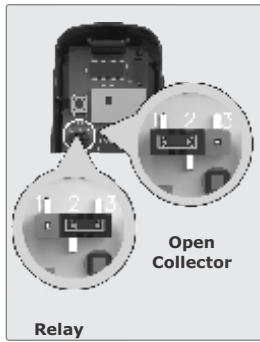

Figure 6.

Open Collector Mode

In sites where current consumption is a factor, for e.g. solar-powered installations, the onboard relay can be disabled by selecting Open Collector Mode. This is accomplished by moving the jumper on the receiver from pins 2 and 3 to pins 1 and 2. The open collector output is then available on the normally-closed (NC) terminal, and will switch down to ground.

Wiring the Receiver

10. The receiver's relay can be connected to the input of an external device using either the normally-open or normally-closed contact shown in the wiring diagrams alongside.

Refer to wiring diagrams for controller connections

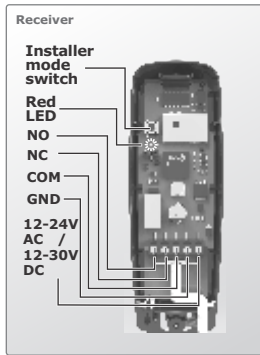

Figure 7.

The NC connection is used most often in gate automation applications to mitigate the problems with wire breaks.



Figure 8.

Wire Routing

11. Break out the relevant knockouts and route the cables through the cable cut-out as shown in the illustration.

Indicators

The receiver has been fitted with a **red LED** for feedback and diagnostic purposes.

- The **red LED** will flash five times on power-up, to indicate that the unit is powering up correctly.
- In Normal Mode of Operation, the **red LED** will flash briefly, once every second, while the IR beam/photocell signal is not detected (i.e. while the IR beam/photocell is obstructed).

7. Beam Alignment

Installer Mode

12. Installer Mode is a unique feature that facilitates the alignment of the beams/photocells by providing audible feedback via the receiver's onboard buzzer. In Installer Mode, the **red LED** will remain on, while the IR beam/photocell signal is not detected (i.e. while the IR beam/photocell is obstructed).

The **red LED** will remain off in both modes, if the beam signal is detected/ aligned.

13. To enter Installer Mode, press and hold the pushbutton on the receiver for a period of one second. The buzzer will emit two beeps to indicate the transition into Installer Mode

Turning on Transmitter

Refer to step 3.

The transmitter has been fitted with a 'power up' jumper. In order to preserve battery life, the unit has been packed with the jumper in the OFF position; to power up the transmitter, simply position the jumper so that it is bridging the ON and COMMON pins as illustrated.

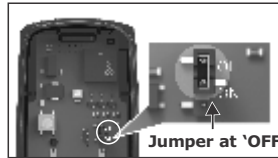

Figure 9.

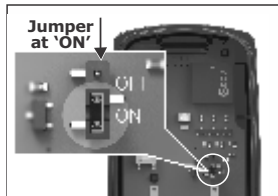

Figure 10.

Once in Installer Mode, the **red LED** will illuminate permanently, while the IR beam signal is not being received by the receiver.

The beam lenses MUST be fitted on the receiver during the alignment procedure as they serve to focus the infrared beam. Failure to do so may result in an inability to achieve alignment. Refer to figure 11a. **Do not screw closed until the beams have been aligned.**

14. Next, proceed with the alignment of the beams, noting the behaviour of the receiver; as soon as the beams are suitably aligned, the LED will switch off and the buzzer will emit a continuous 4KHz tone.
- The receiver will remain in Installer Mode for a period of 120 seconds, but an early exit may be invoked by momentarily pressing the pushbutton.
15. Once optimum alignment has been achieved, mark the location of the **Photon** transmitter on the mounting surface.
16. To prevent damage, switch off the transmitter as shown in figure 9.
17. Mount the transmitter following steps 4-8 above and switch on the transmitter.

Closing

18. Close the units by placing the front cover onto the base as shown in figure 11a. **Do not force the cover, rather place it over as illustrated.**
19. Insert and fasten the "shorter" screw provided to close the two enclosures together, follow by inserting the plastic cover provided. (Refer to figure 11b). The installation is now complete.

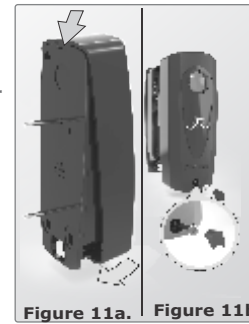

Figure 11a. Figure 11b.

Final Testing

20. Test the operation of the **Photon** infrared beams/photocells by passing an object such as your hand through the beam; there should be an audible 'click' to indicate that the internal relay is being de-energised. If the beams have been connected to an automated system, the operator should immediately halt movement when the beams are obstructed.

If Open Collector is used, there will not be a "click"

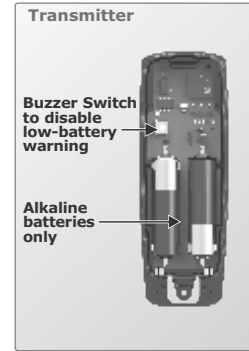

Figure 12.

The transmitter module has been fitted with an onboard buzzer, which provides the following feedback:

The buzzer on the transmitter PCB will emit an alarm tone when the batteries are nearing the end of their functional life. Should the user not have replacement batteries at his disposal at the time of notification, the buzzer can be disabled for a period of 24 hours by momentarily pressing the pushbutton

Connecting double CLOSING Photon Safety Beams/Photocells to V3 Controller

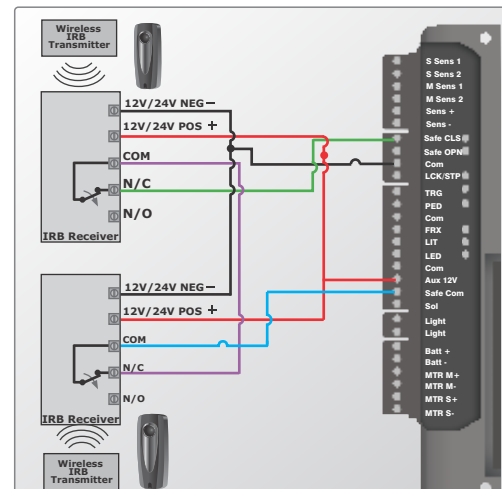

figure 13.

Connecting OPENING Photon Safety Beams/Photocells to D-Series Controller

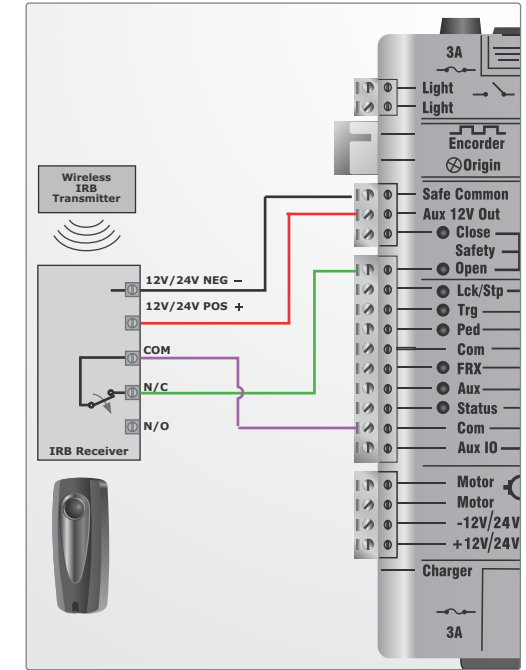

Figure 14a.

Connecting CLOSING Photon Safety Beams/Photocells to D-Series Controller

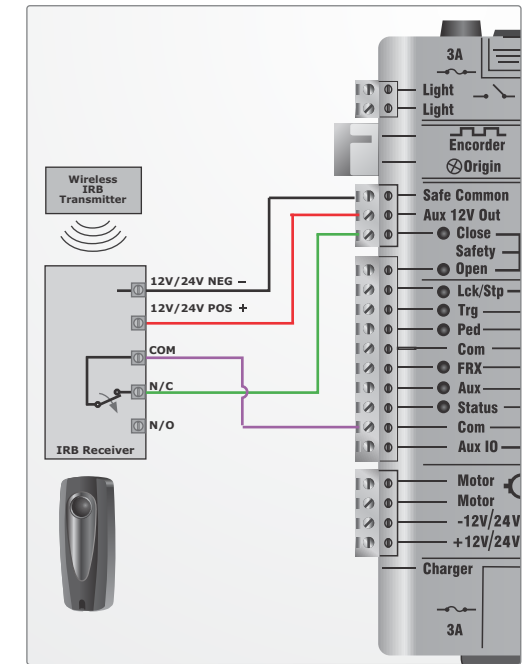

Figure 14a.